

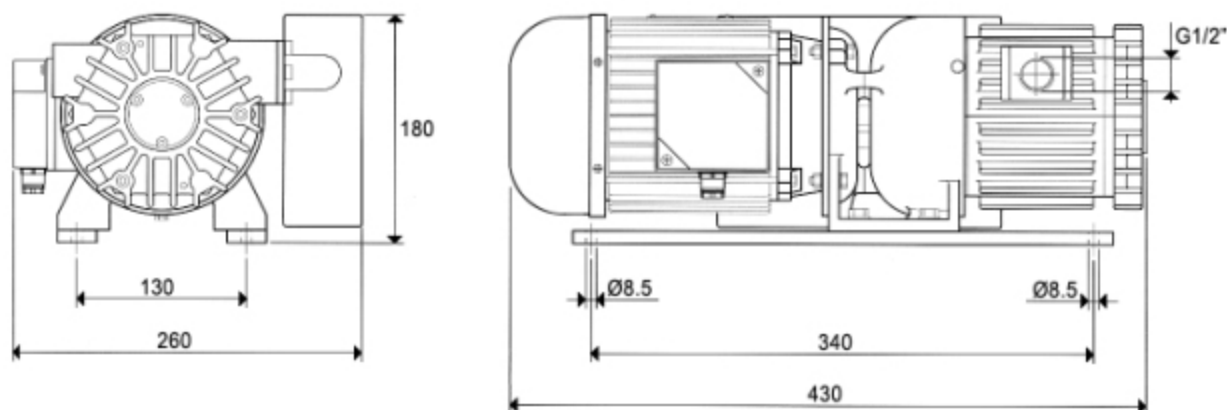

Disegno tecnico



Caratteristiche

Le pompe a secco OMMER, poiché non necessitano di lubrificazione, rendono nulli i controlli e la manutenzione e permettono di avere aria completamente pulita all'uscita della pompa.

Minima rumorosità e durata di esercizio molto lunga, unite ad una esecuzione semplice e compatta, permettono di accedere maggiormente a nuovi settori di utilizzazione.

Frequenza		50Hz	60Hz
Volume aspirato (m ³ /h)		20.0	24.0
Vuoto max (mmHg)		700	
Esecuzione motore (Volt)	3~	230/400±5%	270/470±5%
	1~	230±5%	230±5%
Potenza motore (kW)	3~	0.88	1.00
	1~	0.75	0.90
Protezione Motore (IP)		54	
Velocità di rotazione (giri/min)		1450	1700
Grandezza motore		80	
Peso totale (kg)		26	

Model BVS_20/F



Technical drawing

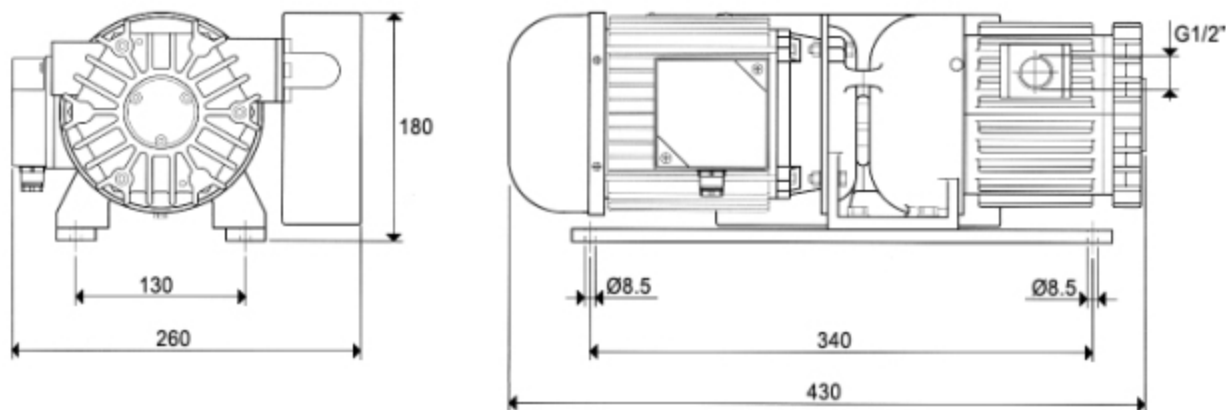

Distinctive features

OMMER non-lubricated vacuum pumps do not require any lubrication and therefore controls and maintenance are not needed, moreover they permit to have completely clean air at the pump outlet.

Low noise and extremely long operation life, together with a simple and compact execution allow to enter new utilization fields more and more.

Frequency		50Hz	60Hz
Sucked volume (m ³ /h)		20.0	24.0
Max. vacuum (mmHg)		700	
Motor execution (Volt)	3~	230/400±5%	270/470±5%
	1~	230±5%	230±5%
Motor power (kW)	3~	0.88	1.00
	1~	0.75	0.90
Motor protection (IP)		54	
Speed (rpm)		1450	1700
Motor size		80	
Total weight (kg)		26	

Technical data and dimensions are not binding. We reserve the right to modify or improve them without notice at any time.