

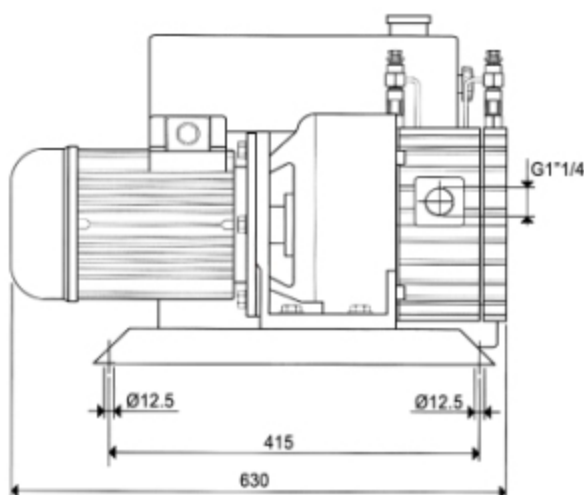

Disegno tecnico

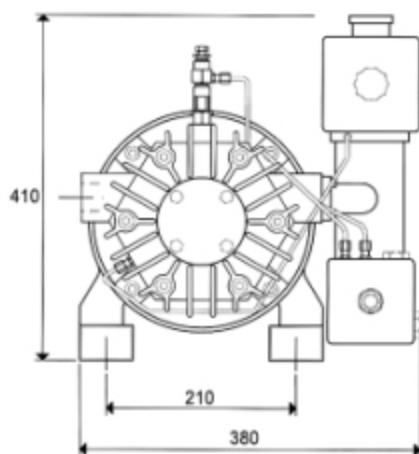

Caratteristiche

Le pompe per vuoto lubrificate OMMER sono caratterizzate da una grande semplicità costruttiva, da una esecuzione robusta, compatta e ben raffreddate. Richiedono una minima esigenza di manutenzione; la lubrificazione in ricircolo permette il cambio dell'olio od il rabbocco a lunghi intervalli di tempo.

Installazione semplice: basta effettuare il collegamento al circuito del vuoto ed il collegamento elettrico del motore.

Frequenza		50Hz	60Hz
Volume aspirato (m <sup>3</sup> /h)		75.0	90.0
Vuoto max (mmHg)		730	
Esecuzione motore (Volt)	3~	230/400±5%	270/470±5%
Potenza motore (kW)	3~	2.20	2.60
Protezione Motore (IP)		54	
Velocità di rotazione (giri/min)		1450	1700
Grandezza motore		100	
Peso totale (kg)		75	

## Model BVL\_75GD1



## Technical drawing

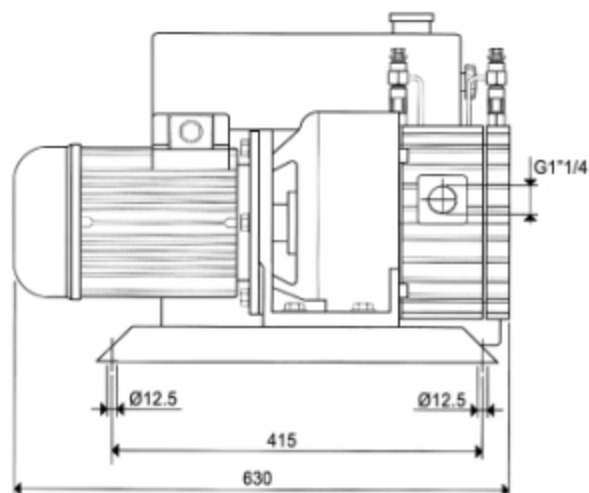
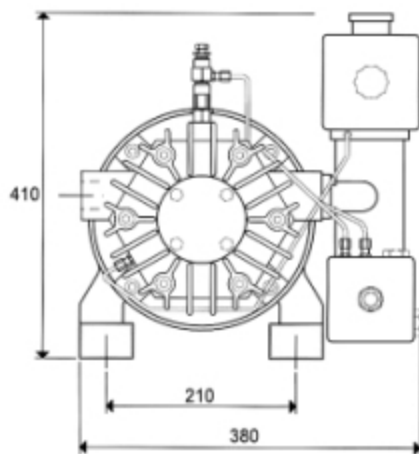

## Distinctive features

OMMER lubricated vacuum pumps are marked out by a very simple construction, a strong and compact execution and an effective cooling system.

They require little maintenance; their loop lubrication allows to change oil or filling up at long intervals.

Easy to install: it is only needed to make connection to the vacuum circuit and make the electric connection of the motor.

Frequency		50Hz	60Hz
Sucked volume (m <sup>3</sup> /h)		75.0	90.0
Max. vacuum (mmHg)		730	
Motor execution (Volt)	3~	230/400±5%	270/470±5%
Motor power (kW)	3~	2.20	2.60
Motor protection (IP)		54	
Speed (rpm)		1450	1700
Motor size		100	
Total weight (kg)		75	

Technical data and dimensions are not binding. We reserve the right to modify or improve them without notice at any time.